



H-OCM

(Outside Corner Male)

The outside corner male is to be used opposite an H-OCF or H-SM and allows for an articulated connection.

H-OCE

(Outside Corner End)

Use with any plain outside corner applications

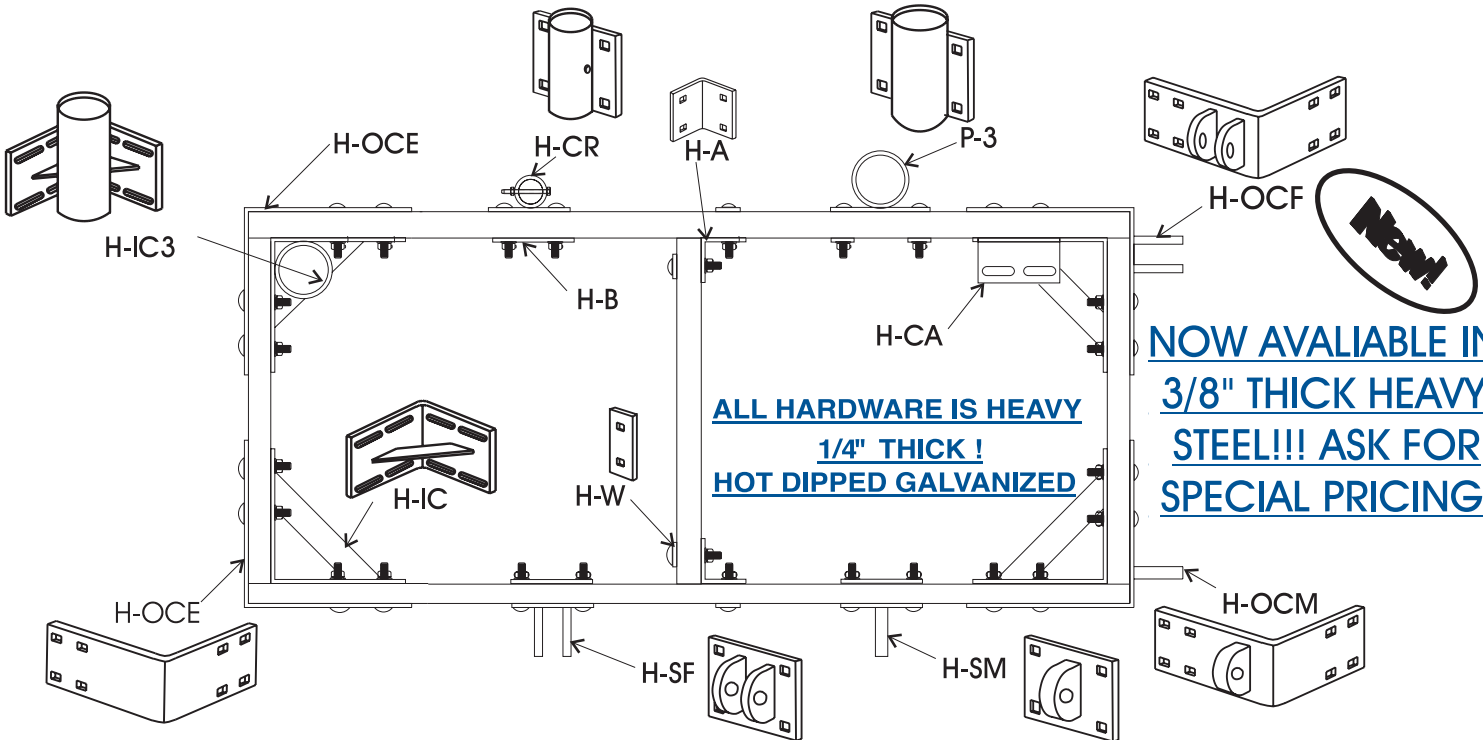
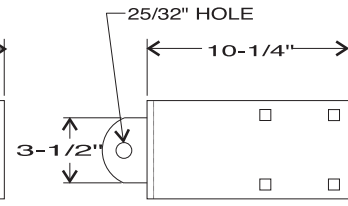
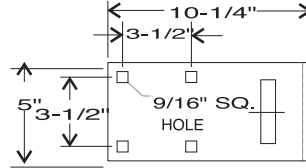
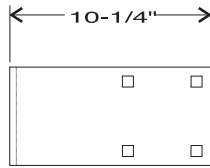
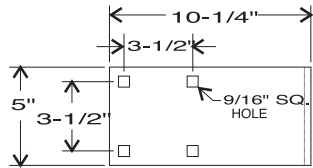
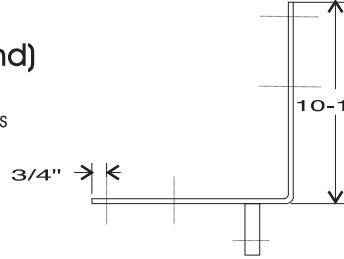
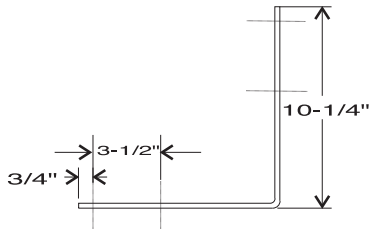

NOW AVAILABLE IN 3/8" THICK HEAVY STEEL!!! ASK FOR SPECIAL PRICING

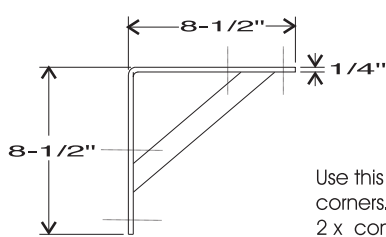

H-IC

(Inside Corner)

Use this inside corner with all outside corners. The slots allow for 2 x and double 2 x construction. The inside gusset helps prevent any racking from occurring.

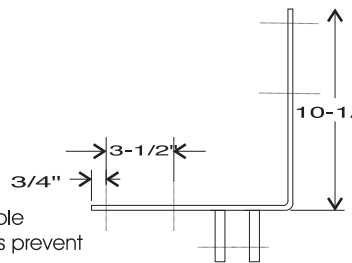

H-OCF

(Outside Corner Female)

The Outside Corner Female is to be used opposite an H-OCM or H-SM and allows for an articulated connection.

